

FLUKE®

1550B
MegOhmMeter

Users Manual

PN 2102980

August 2003, Rev. 1, 6/05

© 2003, 2005 Fluke Corporation. All rights reserved.

All product names are trademarks of their respective companies.

Limited Warranty and Limitation of Liability

Each Fluke product is warranted to be free from defects in material and workmanship under normal use and service. The warranty period is two years and begins on the date of shipment. Parts, product repairs, and services are warranted for 90 days. This warranty extends only to the original buyer or end-user customer of a Fluke authorized reseller, and does not apply to fuses, disposable batteries, or to any product which, in Fluke's opinion, has been misused, altered, neglected, contaminated, or damaged by accident or abnormal conditions of operation or handling. Fluke warrants that software will operate substantially in accordance with its functional specifications for 90 days and that it has been properly recorded on non-defective media. Fluke does not warrant that software will be error free or operate without interruption.

Fluke authorized resellers shall extend this warranty on new and unused products to end-user customers only but have no authority to extend a greater or different warranty on behalf of Fluke. Warranty support is available only if product is purchased through a Fluke authorized sales outlet or Buyer has paid the applicable international price. Fluke reserves the right to invoice Buyer for importation costs of repair/replacement parts when product purchased in one country is submitted for repair in another country.

Fluke's warranty obligation is limited, at Fluke's option, to refund of the purchase price, free of charge repair, or replacement of a defective product which is returned to a Fluke authorized service center within the warranty period.

To obtain warranty service, contact your nearest Fluke authorized service center to obtain return authorization information, then send the product to that service center, with a description of the difficulty, postage and insurance prepaid (FOB Destination). Fluke assumes no risk for damage in transit. Following warranty repair, the product will be returned to Buyer, transportation prepaid (FOB Destination). If Fluke determines that failure was caused by neglect, misuse, contamination, alteration, accident, or abnormal condition of operation or handling, including overvoltage failures caused by use outside the product's specified rating, or normal wear and tear of mechanical components, Fluke will provide an estimate of repair costs and obtain authorization before commencing the work. Following repair, the product will be returned to the Buyer transportation prepaid and the Buyer will be billed for the repair and return transportation charges (FOB Shipping Point).

THIS WARRANTY IS BUYER'S SOLE AND EXCLUSIVE REMEDY AND IS IN LIEU OF ALL OTHER WARRANTIES, EXPRESS OR IMPLIED, INCLUDING BUT NOT LIMITED TO ANY IMPLIED WARRANTY OF MERCHANTABILITY OR FITNESS FOR A PARTICULAR PURPOSE. FLUKE SHALL NOT BE LIABLE FOR ANY SPECIAL, INDIRECT, INCIDENTAL OR CONSEQUENTIAL DAMAGES OR LOSSES, INCLUDING LOSS OF DATA, ARISING FROM ANY CAUSE OR THEORY.

Since some countries or states do not allow limitation of the term of an implied warranty, or exclusion or limitation of incidental or consequential damages, the limitations and exclusions of this warranty may not apply to every buyer. If any provision of this Warranty is held invalid or unenforceable by a court or other decision-maker of competent jurisdiction, such holding will not affect the validity or enforceability of any other provision.

Fluke Corporation
P.O. Box 9090
Everett, WA 98206-9090
U.S.A.

Fluke Europe B.V.
P.O. Box 1186
5602 BD Eindhoven
The Netherlands

Visit Fluke's web site at: www.fluke.com

Table of Contents

Title	Page
Introduction	1
Contacting Fluke	1
Unpacking the Meter	2
Safety Information	3
Symbols	4
Operating the Meter	4
Turning the Meter On and Off	4
Using the Pushbuttons	5
Understanding the Display	6
Charging the Battery	6
Using the Guard Terminal	8
Making Measurements	10
Connecting to the Circuit Under Test	10
Selecting a Pre-set Test Voltage	11
Programming a Test Voltage	12
Selecting a Ramp or Steady-State Test	13
Setting a Timed Test	13
Polarization Index (PI)	14
Dielectric Absorption Ratio	14
Capacitance	14
Performing an Insulation Test	14
Storing the Test Results	16
Viewing Results Stored in Memory	17
Downloading Your Test Results	18
Installing FlukeView Forms Basic Software	18
Downloading Results to PC	19
Deleting Your Test Results	19
Maintaining the Meter	20
Cleaning	20
Principle of Measurement and Resistance	20
Specifications	22
General Specifications	22
Electrical Specifications	23
Warranty in Other Languages	24

List of Tables

Table	Title	Page
1.	Symbols	4
2.	List of Replacable Parts	21
3.	1550B Accessories	21

List of Figures

Figure	Title	Page
1.	Standard Items Provided	2
2.	Pushbuttons	5
3.	Display Features	6
4.	Power Supply Connections	7
5.	Surface Leakage Current	8
6.	Guard Terminal Connection	9
7.	Improved Guard Terminal Connection	9
8.	Connecting to the Circuit Under Test	10
9.	IR Port on 1550B MegOhmMeter	18

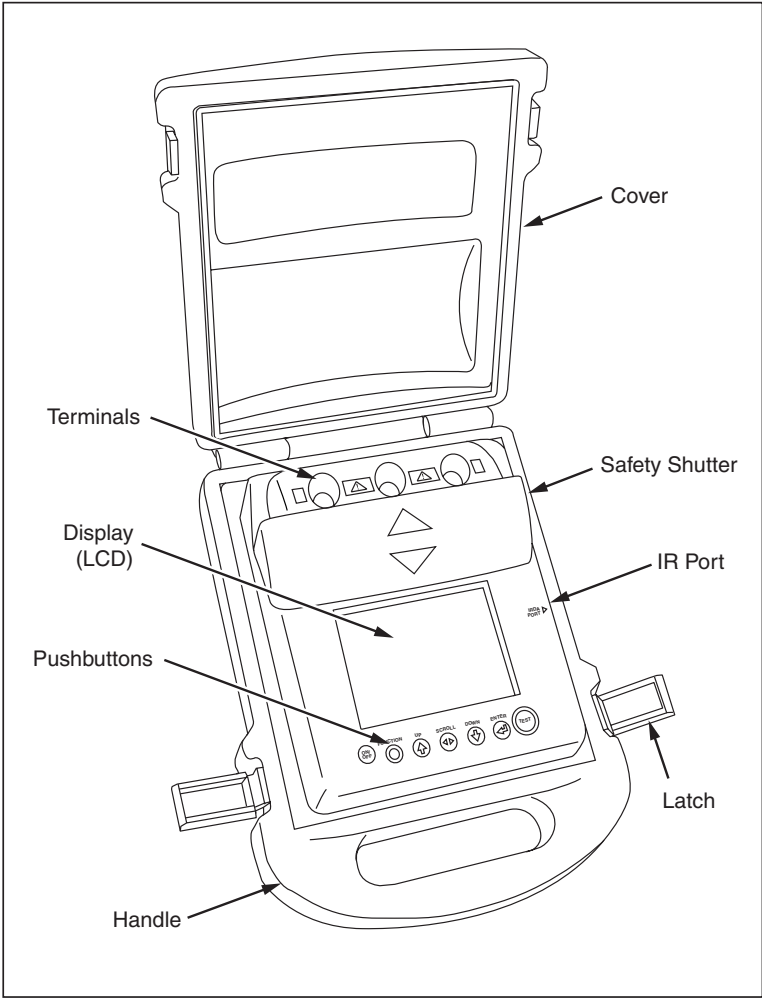

Fluke 1550B MegOhmMeter

asw16F.EPS

1550B MegOhmMeter

Introduction

The Fluke 1550B MegOhmMeter (hereafter "the Meter") is a high voltage insulation tester for testing general circuits, including switchgear, motors, and cables.

The Meter has the following features:

- ⇒ Large liquid crystal display (LCD) with text display
- ⇒ Five pre-set test voltage: 250 V, 500 V, 1000 V, 2500 V, and 5000 V
- ⇒ Programmable test voltage: 250 V to 5000 V (50/100 V steps)
- ⇒ Resistance measurement: 0 Ω to 1 T Ω
- ⇒ Polarization Index (PI) measurement
- ⇒ Dielectric Absorption Ratio (DAR) measurement
- ⇒ Ramp mode that linearly increases (100 V/s) the applied test voltage
- ⇒ Test timer and storage for test results with user settable ID tag
- ⇒ Breakdown voltage indication
- ⇒ Rechargeable lead-acid battery
- ⇒ Auto shutoff after 30 minutes of inactivity
- ⇒ Infrared (IR) port for downloading test data
- ⇒ PC software supplied

The Meter meets EN 61557 Parts 1 and 2; and EN 61010-1, CAT III 600 V Pollution Degree 2 standards. CAT III equipment is designed to protect against transients in equipment in fixed-equipment installations, such as distribution panels and lighting systems in large buildings.

Contacting Fluke

To contact Fluke for product information, operating assistance, service, or to get the location of the nearest Fluke distributor or Service Center, call:

- 1-888-99FLUKE (1-888-993-5853) in U.S.A.
- 1-800-36-FLUKE (1-800-363-5853) in Canada
- +31-402-675-200 in Europe
- +81-3-3434-0181 Japan
- +65-738-5655 Singapore
- +1-425-446-5500 from other countries

Visit Fluke's web site at: www.fluke.com.

Register your Meter at register.fluke.com.

Unpacking the Meter

The Meter comes with the items shown in Figure 1. If the Meter is damaged or an item is missing, contact the place of purchase immediately.

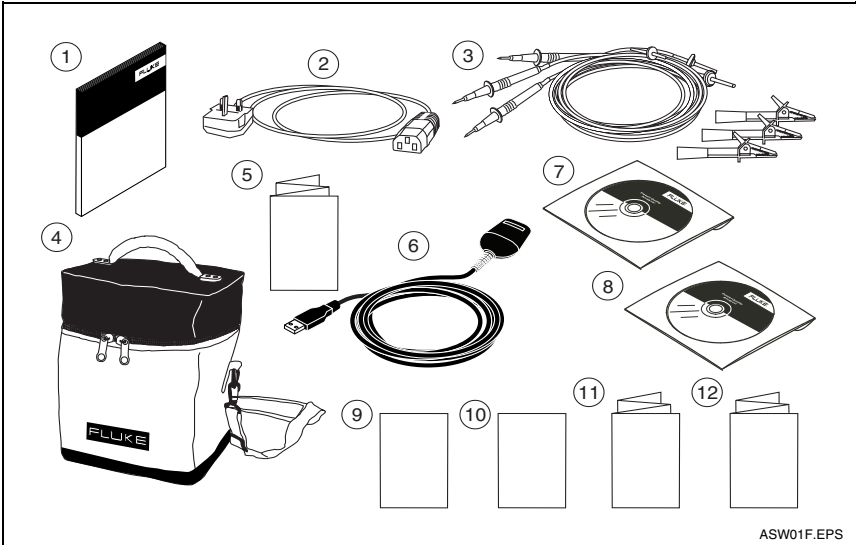

ASW01F.EPS

Item	Description
①	English Manual
②	AC Power Cord
③	⚠ Test Cables with Alligator Clips (red, black, green)
④	Soft Carrying Case
⑤	Quick Reference Card
⑥	Infrared Adapter with interface cable
⑦	CD containing Users Manual
⑧	CD containing FlukeView Forms Basic
⑨	Software License Agreement
⑩	Registration Card
⑪	FlukeView Forms Installation Guide
⑫	USB-IR Cable Installation Guide

Figure 1. Standard Items Provided

⚠ ⚠ Warning

Use only recommended test leads. The supplied test leads are for use with this instrument only. Do not use with other equipment

Safety Information

⚠ ⚠ Warning

Before and after testing, confirm that the Meter does not indicate the presence of a hazardous voltage. (See Figure 3.) If the Meter beeps continuously and a hazardous voltage is shown on the display, disconnect test leads and remove power from the circuit under test.













⚠ ⚠ Warning: Read Before Using the Meter

- To avoid possible electric shock or personal injury:
- Use the Meter only as specified in this manual. Otherwise the protection provided by the Meter might be impaired.
- Do not disconnect the test leads before the test has been completed and the test voltage at the terminals has returned to zero. This ensures that any charged capacitance is fully discharged.
- Ensure there is no power to the circuit under test and that all circuit capacitances are fully discharged prior to testing with this instrument.
- Avoid working alone or around explosive gas, vapor or dust.
- Do not use the Meter in a wet environment.
- Inspect the test leads for damaged insulation or exposed metal. Check test lead continuity. Replace damaged leads. Do not use the Meter if it looks damaged.
- Use care when working above 30 V ac rms, 42 V ac peak and 60 V dc. Such voltages pose a shock hazard.
- When using the probes, keep your fingers behind the finger guards.
- Impedances of additional operating circuits connected in parallel can adversely affect measurements.
- Place test leads in proper input terminals.
- Do not use the Meter with any parts or cover removed.
- Use only Fluke approved replacement parts, and accessories as specified in this manual.
- Do not use the Meter if the safety shutter is impaired in any way. The safety shutter (see Frontispiece) prevents access to the test terminals and charger terminals at the same time.
- There are no user replaceable parts inside the instrument.
- Use the guard terminal only as specified in this manual. Do not allow other accessories or foreign objects to come into contact with the guard terminal as safety may be compromised.
- Do not use in distribution systems with voltages higher than 660 V.

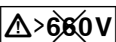
Symbols

Symbols on the Meter and in the manual are explained Table 1.

Table 1. Symbols

	Conforms to European Union standards.
	TUV GS
	This product complies with UL3111-1, CAN/CAS C22.2 No.1010.1 for Test and Measurement Equipment
	Risk of danger. Important information. See Manual.
	Potentially hazardous voltage
	Equipment protected by double or reinforced insulation.
	Do not use in distribution systems with voltages higher than 660 V.
	Interference is present. Displayed value might be outside of specified accuracy.
	Ramp mode indicator
	Electrical breakdown
	Volts AC
	Earth Ground

Operating the Meter**Turning the Meter On and Off**

To turn the Meter on and off:

1. Press  to turn on the Meter.

The Meter performs a self-check, self-calibration, displays the current software version, and starts in the Test Voltage mode.

At this point, you can:

- ⇒ Change test parameters
- ⇒ Start an insulation test
- ⇒ View stored test results
- ⇒ Download test results

2. Press  again to turn off the Meter.

Using the Pushbuttons

Use the pushbuttons (Figure 2) to control operation of the Meter, select test results for viewing, and scroll through selected test results.

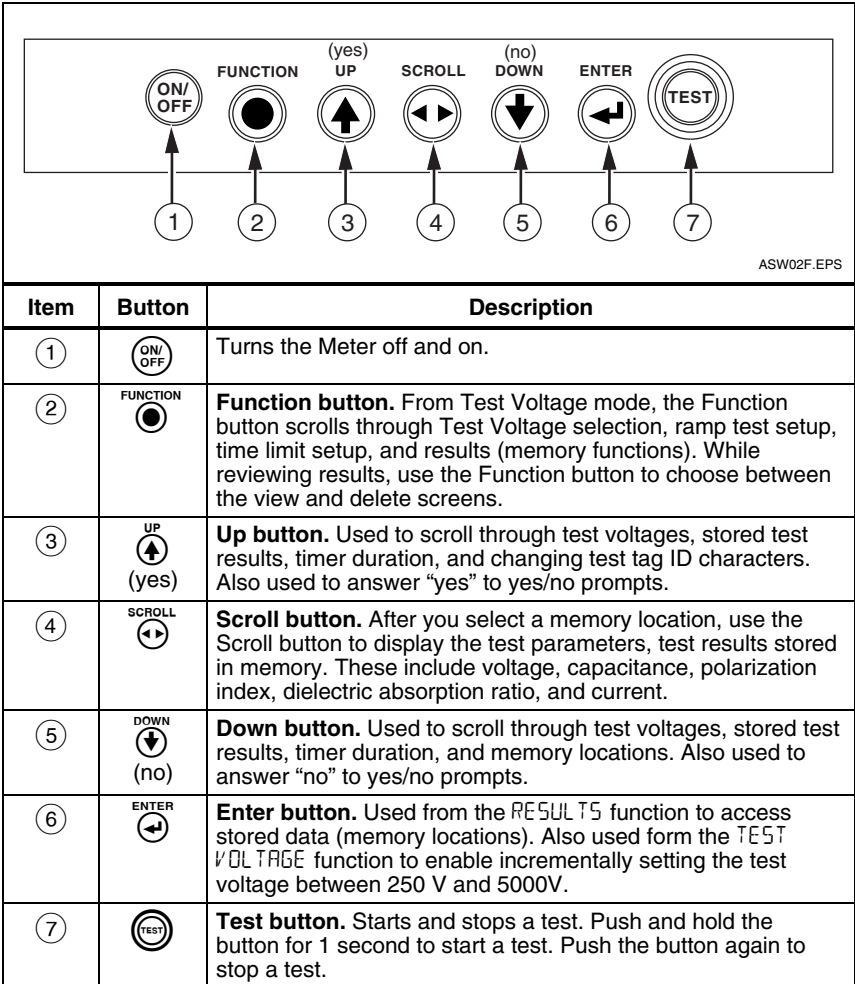
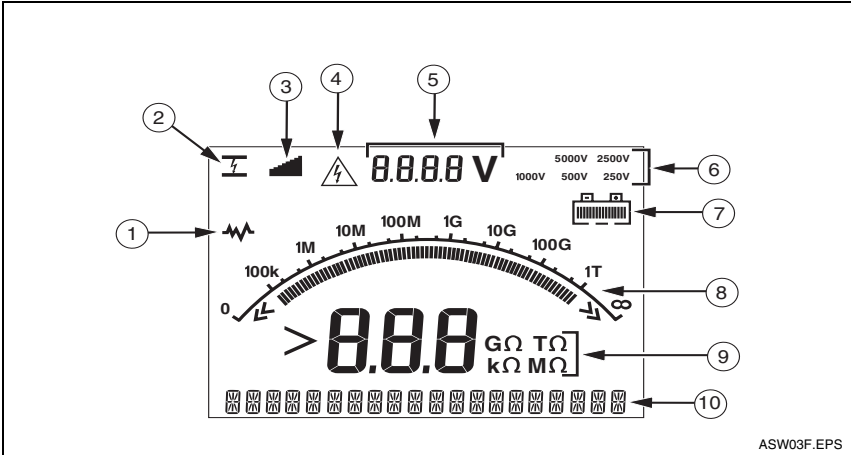

Figure 2. Pushbuttons

Understanding the Display

Display annunciators are shown and described in Figure 3.



ASW03F.EPS

Item	Description
①	Interference present. Displayed readings may be outside the specified accuracy range.
②	Electrical breakdown in Ramp mode.
③	Ramp mode indicator.
④	Potentially hazardous voltage is present at the test terminals. ⚠ ⚠ Warning: Before and after testing, confirm that the Meter does not indicate the presence of a hazardous voltage. If the Meter beeps continuously and a hazardous voltage is present, disconnect test leads and remove power from the circuit under test.
⑤	Voltage sourced by the Meter or from the circuit under test that is present at terminals of the Meter.
⑥	Test voltage selection (250 V, 500 V, 1000 V, 2500 V, or 5000 V)
⑦	Battery charge status.
⑧	Bar graph display of insulation resistance.
⑨	Digital display of insulation resistance.
⑩	Text display. Indicates voltage, test current, capacitance, programmable test voltages, and menu options.

Figure 3. Display Features

Charging the Battery

⚠ ⚠ Warning

To avoid possible electric shock or personal injury, disconnect the test leads from the Meter before charging the battery.

Pb  **Note**

This Meter uses a rechargeable 12 V lead-acid battery for power. Do not mix with the solid waste stream. Use a qualified recycler or hazardous materials handler to dispose of dead batteries. Contact your authorized Fluke Service Center for disposal and recycling information.

Storing rechargeable lead-acid batteries in a low-charged state could lead to reduced life and/or damage. Fully charge the battery before storing it for extended periods and check the charge at regular intervals.

The Meter uses a rechargeable 12 V lead-acid battery for power. You can recharge the battery using the AC power cord.

Fully charging the battery typically takes 12 hours. Avoid charging in extremes of temperature. Recharge the battery if the Meter has been stored for extended periods. Figure 4 shows how to connect the Meter to a power supply.

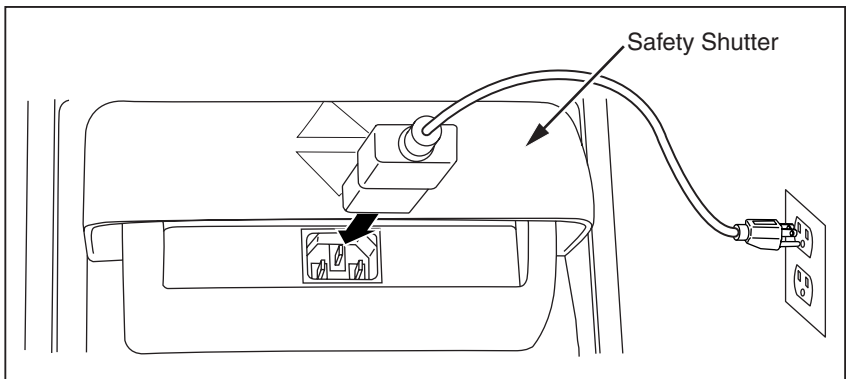

Figure 4. Power Supply Connections

To recharge the battery using an AC power supply:

1. Turn off the Meter.
2. Disconnect the test leads from the Meter.
3. Rotate the safety shutter toward the top of the Meter to expose the power supply connection.
4. Connect the AC power cord to the IEC AC power socket (①) on the Meter.
5. Connect the other end of the power cord to an AC power supply. See “General Specifications” later in this manual for AC charger input specifications.
6. The LCD on the Meter displays **CHARGING**. When the Meter is in Charging mode, downloading is possible.

Using the Guard Terminal

Note

Insulation resistance is measured between the + and – output connections. The Guard terminal (G) is at the same potential as the negative (–) terminal but is not in the measurement path.

For most tests, only two test leads are used, connecting the positive (+) and negative (–) terminals on the Meter to the circuit under test. The Guard (G) terminal is left unconnected.

When measuring very high resistances, you can obtain more accurate readings by making a three-wire measurement using the Guard terminal. The Guard terminal is at the same potential as the negative (–) terminal, and can be used to prevent surface leakage or other unwanted leakage currents from degrading the accuracy of the insulation resistance measurement.

Figure 5 shows how to measure the resistance from one of the conductors to the outer shield. In this case, there is a leakage current along the surface of the inner insulation near the end of the cable. This leakage adds to the current that the negative terminal detects, and will cause the Meter to read a lower resistance than it should.

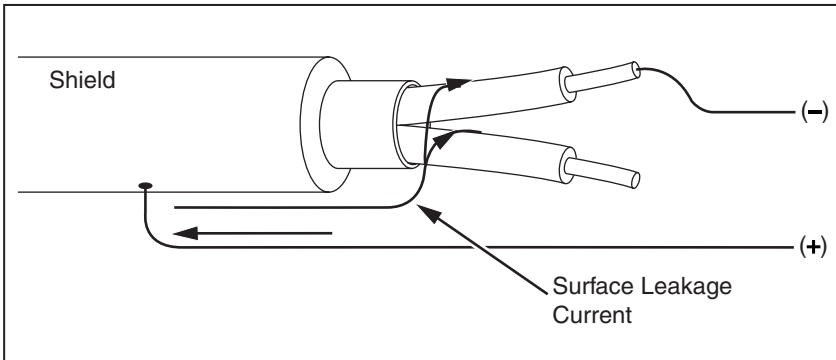

ASW13F.EPS

Figure 5. Surface Leakage Current

Figure 6 shows how to prevent surface current leakage by connecting a lead from the Guard terminal to a conductor wrapped around the inner insulation. The surface leakage current is directed to the Guard terminal. This removes the leakage current from the measurement path between the positive and negative terminals, and improves the accuracy of the test readings.

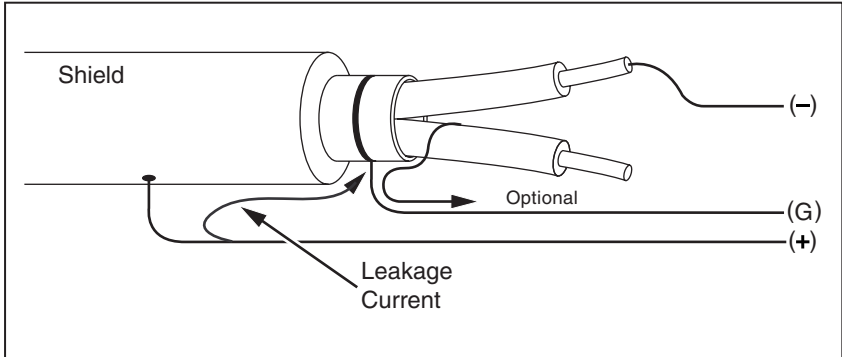

ASW14F.EPS

Figure 6. Guard Terminal Connection

Figure 7 shows how to improve the measurement setup by connecting the Guard terminal to the unused wire and coupling it to the inner insulation. This insures that the Meter measures the leakage between the selected conductor and the outer shield, but eliminates the leakage path between conductors.

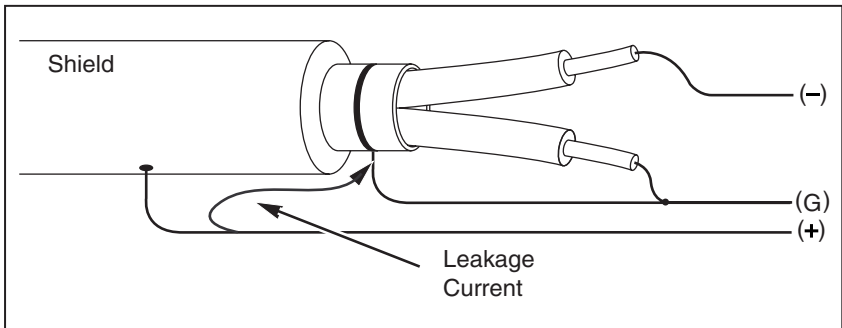

ASW15F.EPS

Figure 7. Improved Guard Terminal Connection

Making Measurements

Connecting to the Circuit Under Test

⚠ ⚠ Warning

To avoid possible electric shock or personal injury:

- Remove all power from the circuit under test and discharge circuit capacitance before testing a circuit with the Meter.
- Connect the test leads to the Meter inputs before connecting to the circuit under test.
- Before and after testing, confirm that the Meter does not indicate the presence of a hazardous voltage at the terminals. If the Meter beeps continuously and a hazardous voltage is shown on the display, disconnect test leads and remove power from the circuit under test.

To connect to the circuit under test:

1. Rotate the safety shutter to expose the terminal connections.
2. Insert the test leads in the terminals shown (Figure 8), and connect the test leads to the circuit under test.

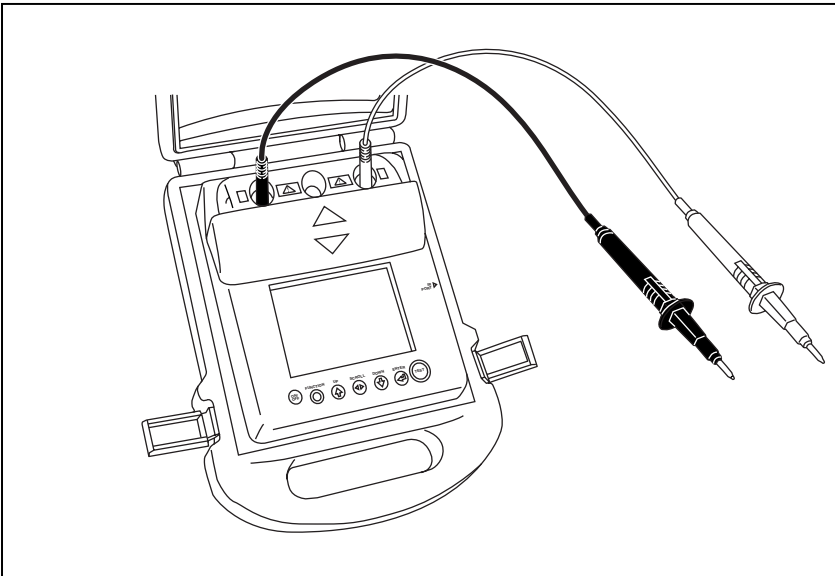

ASW09F.EPS

Figure 8. Connecting to the Circuit Under Test

Note

The 1550B is NOT specified below 200 k Ω . This means shorting the leads and performing a test, results in an unspecified but above zero reading. This is normal for this meter's input circuitry configuration and does not affect readings that are within the specified accuracy range.

Options to Consider Before Making an Insulation Test

In addition to performing a basic insulation test, the Meter includes a series of features/functions that allow you to more precisely tailor the test to your requirements. These include defining a test voltage, selecting a ramp test, setting a time limit (duration) for the test, measuring polarization index (PI), measuring dielectric absorption ratio (DAR), and measuring capacitance. Each of these features is described in the following paragraphs. These features can be used in combination and should be set, cleared, or accounted for (as appropriate) before initiating an insulation test.



Selecting a Pre-set Test Voltage

To select a pre-set test voltage:

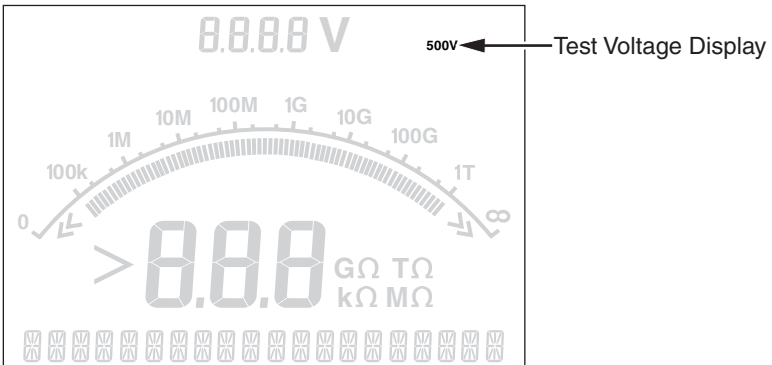
1. With the Meter turned on, press the  button to select TEST VOLTAGE.



ASW05F.EPS

2. Press the  or  button to scroll through the pre-set test voltage options (250 V, 500 V, 1000 V, 2500 V, and 5000 V).

The selected test voltage appears in the upper-right of the display.

Note

The actual test voltage can be up to 10 % higher than the selected test voltage.





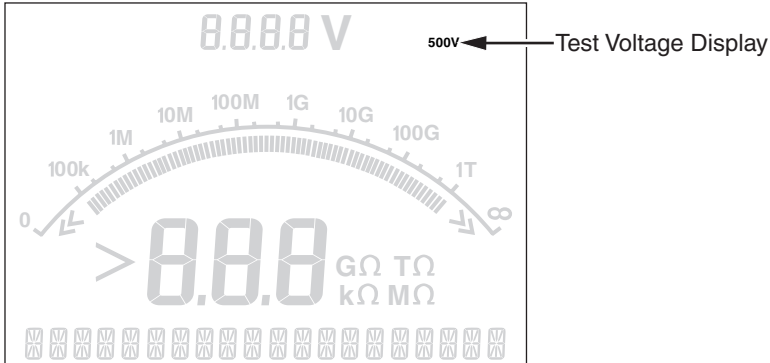

Programming a Test Voltage

To set a test voltage in between the pre-set test voltages proceed as follows:

1. With the Meter turned on, press the  button to select TEST VOLTAGE.



ASW05F.EPS

2. Press the  or  button to scroll through the pre-set test voltage options (250 V, 500 V, 1000 V, 2500 V, and 5000 V). Select the voltage closest to the level required.
The selected test voltage appears in the upper-right of the display.
3. Press the  button. $TV = xxxV$ appears flashing in the lower-left of the display.
4. Press the  and  buttons to increment and decrement the voltage. When the correct voltage level shows, **do not** press the  button. Doing so will return the test voltage to the next lowest last pre-set voltage selection. Instead press the  button to go to the next function.

Note

The test voltage can be up to 10 % higher than the test voltage you select.

Selecting a Ramp or Steady-State Test

The ramp-test function is an automated test that checks insulation for a breakdown. During a ramp test, the output voltage starts at 0 V and increases linearly (100 V/s) until it reaches the specified test voltage or until a sudden drop in measured resistance is detected. Then, the Ramp stops, the test voltage drops to zero, and the voltage at the breakdown point is stored in memory on the Meter. All other test results are declared invalid if the test does not reach the specified test voltage. If the test successfully meets compliance without breakdown, then the only valid test results are test voltage and insulation resistance.

To enable or disable the ramp function proceed as follows:

1. With the Meter turned on, press the **FUNCTION** button to select the **RAMP TEST** function.

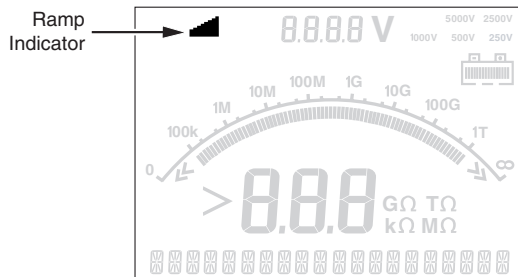

ASW07F.EPS

2. Press **UP** or **DOWN** to toggle the Ramp on or off. When the ramp is on a blinking  appears in the upper left-hand corner of the display.

Setting a Timed Test

You can control the length of an insulation test by setting a timer. The time (test duration) can be set in 1-minute increments up to 99 minutes. During a timed test, the time limit appears on the right bottom of the display, and the elapsed time is shown in the middle of the display. At the end of the elapsed time, the insulation test has been completed and the test is terminated.

To set a test time limit, proceed as follows:

1. With the Meter turned on, press the **FUNCTION** button to select the **TIME LIMIT** function.
2. Repeatedly press the **UP** button to increment and set the test time (in 1-minute intervals).

Polarization Index (PI)

As part of the insulation test, the Meter measures and stores polarization index (PI), when appropriate. Since, by definition, a polarization index test requires 10 minutes to complete, it is measured and stored as invalid data for all insulation tests under 10 minutes. When an insulation test is 10 minutes or more the polarization test is completed and stored. The results are available for display during a test by pressing the  button or by storing the test results and scanning the RESULTS fields. The field is identified by PI:-.

$$PI = \frac{R \times 10 \text{ min}}{R \times 1 \text{ min}}$$

Dielectric Absorption Ratio

As part of the insulation test, the Meter measures and stores dielectric absorption ratio (DAR), when appropriate. Since, by definition, a DAR test requires 1 minute to complete, it is measured and stored as invalid data for all insulation tests under 1 minute. When an insulation test is 1 minute or more the DAR test is included in the results. The results are available for display during a test by pressing the  button or by storing the test results and scanning the RESULTS fields. The field is identified by DAR:-.

$$DAR = \frac{R \times 1 \text{ min}}{R \times 30 \text{ sec}}$$

Capacitance

As part of the insulation test, the Meter measures and stores capacitance when appropriate. The results are available for display during a test by pressing the  button or by storing the test results and scanning the RESULTS fields. The field is identified by C:-.

Performing an Insulation Test**  Warning**

Measuring insulation resistance requires the application of potentially dangerous voltages to the circuit. This may include exposed bonded metalwork.

To avoid possible electric shock or personal injury:

- **Remove all power from the circuit under test and discharge circuit capacitance before testing a circuit with the Meter.**
- **Before proceeding, ensure that the installation is wired correctly and no personnel are endangered by any tests.**
- **First connect the test leads to the Meter inputs before you make connection to the circuit under test.**

To perform an insulation test use the following procedure:

1. With the Meter turned on, set the available measurement options to meet your test requirements. These include:
 - Test Voltage – Set range: 250V to 5000 V (50 V/100 V steps)
 - Ramp Test – Toggle on or off
 - Time Limit – No limit or from 1 to 99 minutes
2. Connect the probes to the circuit you want to test.

⚠ ⚠ Warning

To avoid possible electric shock or personal injury: before and after testing, confirm that the Meter does not indicate the presence of a hazardous voltage at the terminals. If the Meter beeps continuously and a hazardous voltage is shown on the display, disconnect test leads and remove power from the circuit under test.

3. Press the  button for 1 second to start the insulation test.

The Meter beeps 3 times as the test begins, and the  icon flashes on the display indicating potentially hazardous voltages may be present on the test terminals.



ASW08F.EPS

The digital display indicates the measured insulation resistance after the circuit has stabilized. The bar graph displays this value continuously (in real time) as a trend.

Any of the following conditions will terminate an insulation test:

- User stop (Pressing the  button).
- Timer limit reached
- Interference on the test circuit
- Breakdown occurs with ramp test enabled
- *Battery depleted*

If breakdown occurs with ramp test enabled, press the  button before going to step 4.







Following termination of an insulation test the Meter beeps when a potentially hazardous voltage remains on the test terminals due to charged-circuit capacitance or from the presence of an external voltage.

4. When the test is terminated, `STORE RESULT?` is displayed. If appropriate, store the test results as described in the next procedure. Otherwise, terminate the `STORE RESULT?` prompt by pressing the  button. The results are not stored.

Storing the Test Results

Upon completion of an insulation test, the Meter displays `STORE RESULT?` as a prompt to save the measurement results for future use. The Meter includes enough memory to store the results of 99 insulation tests for future use.

To store the results of an insulation test use the following procedure:

1. Press  to save the measurement results. The Meter will assign and display a sequential tag number (00 to 99) to identify the measurement. If the tag number is acceptable, press the  button to store the data. If a different tagging convention is required, proceed as follows to provide a custom 4-character tag.
 - a. Notice that an * is blinking on the display. This is the first of the four characters available for tagging the test results. Repeatedly press the  button to cycle through the character positions.
 - b. At each character position use the  and  buttons to assign a character (0-9, A-Z).
 - c. Press the  button to store the results.

Viewing Results Stored in Memory

Note

Parameters not appropriate for a test are shown as *INVALID*.

The Meter can store 99 sets of test data, including:

- ⇒ Tags
- ⇒ Ramp on or off
- ⇒ Insulation Resistance
- ⇒ Timer reading at termination of test (Timer)
- ⇒ Test Voltage Selected (TV)
- ⇒ Actual Test voltage (V)
- ⇒ Capacitance (C)
- ⇒ Polarization Index (PI)
- ⇒ Dielectric absorption ratio (DAR)
- ⇒ Test current (I)
- ⇒ Reason for ending the test
- ⇒ Limit – off or timer setting (1 to 99 minutes) (T. Limit)

To view stored test data:

1. With the Meter turned on, press the  button to select the **RESULTS** function.

Note



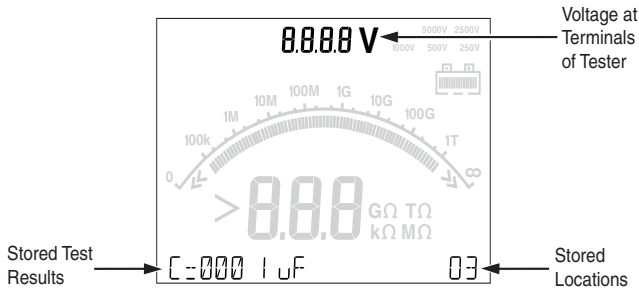

When a voltage is present at the terminals, that voltage is always shown on the top-center of the display, regardless of whether that voltage is sourced by the Meter or is from the circuit under test.



ASW06F.EPS

1550B

Users Manual

2. Press  to access the test results storage locations. The ID tag location appears on the bottom-right of the display.
3. Press  or  to step through the stored locations.
4. Stop at the location you want to view.
5. Press  to view the stored test data for a specific test. Test data appears on the alphanumeric text display and on the LCD.
6. Press  to return the Meter to Test Voltage mode.

Downloading Your Test Results

You can use FlukeView Forms software to download all of your stored test data to a PC. An infrared adapter is supplied with the Fluke 1550B MegOhmMeter for use in downloading stored test data. Figure 9 shows the location of the IR port on the Meter.

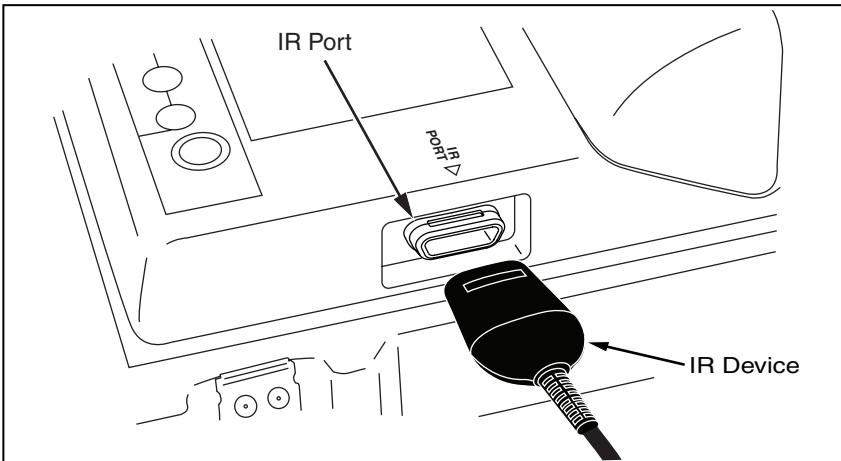

ASW04F.EPS

Figure 9. IR Port on 1550B MegOhmMeter

Installing FlukeView Forms Basic Software

You need to install FlukeView Forms Basic software on your PC to download stored test data.

To install FlukeView Forms Basic, see the *FlukeView Forms Installation Guide*.

To install the infrared adapter, see the *USB-IR Cable Installation Guide*.

Downloading Results to PC

Note

Before the USB-IR cable can be used, software drivers must be installed on your Windows PC. See the USB-IR Installation Guide for more information.

To connect the 1550B to the PC for use with *FlukeView Forms Basic Documenting Software*:

1. The 1550B should not be running a test; otherwise, serial communications will be disabled.
2. Connect the USB-IR cable to an available USB port on the PC.
3. Attach the IR device to the IR port on the 1550B.
4. Open *FlukeView Forms Basic Documenting Software*.
5. The current COM serial port setting is displayed at the bottom right of the *FlukeView Forms Basic* window. Double-click on it to change the COM port setting to the virtual COM port used by the USB-IR cable.
6. Turn the 1550B MegOhmMeter on.
7. Follow the instructions for transferring data from the 1550B to the PC found in the online *FlukeView Forms Users Manual*.

Note







Verify that the download was successful before deleting the stored test results on the Fluke 1550B.

Note

*Results data stored in the Meter can be deleted from the PC using the *FlukeView Forms Basic* application. See the *FlukeView Forms Users Manual* file for details.*

Deleting Your Test Results

To delete all of the saved test results:

1. With the Meter turned on, press  to select the RESULTS function.
2. Press  to access the stored test results.
3. Press  once to access the DELETE ? function.
4. Press . The REALLY DEL ? prompt appears.
5. Press  to confirm the deletion or press  to return to Test Voltage mode.
When you press , all stored test results are permanently deleted.

Note

Individual test locations cannot be deleted, however, they can be overwritten.

⚠ Caution

The delete function deletes all of your stored test results.

Maintaining the Meter**⚠⚠ Warning**

To avoid possible electric shock or personal injury, do not attempt to repair or service your Meter beyond what is described in this manual. Only qualified service personnel should service the product.

There are no user-replaceable parts inside the Meter.

Cleaning**⚠⚠ Warning**

To avoid possible electric shock or personal injury, remove excess water from the cloth before cleaning the Meter to ensure that water does not enter any terminal.

Periodically wipe the case with a damp cloth and mild detergent. Do not use abrasives or solvents to clean the Meter.

Principle of Measurement and Resistance

The Meter measures insulation parameters and displays the results using with the following formulas.

**Ohm's
Law**

$$R = \frac{V}{I}$$

**Capacitance
(charge)**

$$C = \frac{Q}{V}$$

**PI
(Polarization Index)**

$$PI = \frac{R \times 10 \text{ min}}{R \times 1 \text{ min}}$$

**DAR
(Dielectric
absorption ratio)**

$$DAR = \frac{R \times 1 \text{ min}}{R \times 30 \text{ s}}$$

Replaceable Parts and Accessories

Table 2 lists the replaceable parts that are available for the Meter. Table 3 identifies the Accessories available for use with the Meter.

Table 2. List of Replaceable Parts



Parts	Part No.
Test Lead – Red	1642584
Test Lead – Black	1642591
Test Lead – Green	1642600
Test Clip – Red	1642617
Test Clip – Black	1642621
Test Clip – Green	1642639
AC Power Cord (North America)	284174
AC Power Cord (Continental Europe)	769422
AC Power Cord (UK)	769455
AC Power Cord (Australia)	658641
AC Power Cord (S. Africa)	1552363
Soft Carrying Case	1642656
Infrared Cable Assembly	1578406
Users Manual CD	2099928
English Users Manual	2102980
Quick Reference Card	2099943

Table 3. 1550B Accessories

Accessories	Part No.
Extended Test Lead Set, 25 feet (7.6 meters)	2032761

Specifications

General Specifications

Display	75 mm x 105 mm	
Power	12 V lead-acid rechargeable battery. Yuasa NP2.8-12	
Charger Input (AC)	85 V to 250 V ac 50/60 Hz 20 VA This Class II (double insulated) instrument is supplied with a Class 1 (grounded) power cord. The protective earth terminal (ground pin) is not connected internally. <u>The extra pin is for added plug retention only.</u>	
Dimensions (H x W x L)	170 mm x 242 mm x 330 mm (6.7 in. x 9.5 in. x 13.0 in.)	
Weight	3.6 kg (7.94 lbs.)	
Temperature (operating)	-20 °C to 50 °C (-4 °F to 122 °F)	
Temperature (storage)	-20 °C to 65 °C (-4 °F to 149 °F)	
Humidity	80 % to 31 °C decreasing linearly to 50 % at 50 °C	
Altitude	2000 m	
Enclosure Sealing	IP40	
Input Overload Protection	600 V AC	
Electromagnetic Compatibility	EN 61326	
Certifications	CE  	
Safety Compliance	EN 61010, EN 61557 Parts 1 and 2 IEC 61010-1, CAT III V 600, Pollution Degree 2	
Typical Battery Charge Capability Note At temperature extremes, the battery needs to be charged more frequently.	Test Voltages	Number of Tests
	250 V	4138
	500 V	3913
	1 kV	3462
	2.5 kV	2043
	5 kV	1000

Electrical Specifications

The meter's accuracy is specified for 1 year after calibration at operating temperatures of 0 °C to 35 °C. For operating temperatures outside the range (-20 °C to 0 °C and 35 °C to 50 °C), add ± .25 % per °C, except on the 20 % bands add ± 1 % per °C.

Insulation		
Test Voltage (DC)	Insulation Resistance Range	Accuracy (+/- reading)
250 V	<200 kΩ 200 kΩ to 5 GΩ 5 GΩ to 50 GΩ >50 GΩ	unspecified 5 % 20 % unspecified
500 V	<200 kΩ 200 kΩ to 10 GΩ 10 GΩ to 100 GΩ >100 GΩ	unspecified 5 % 20 % unspecified
1000 V	<200 kΩ 200 kΩ to 20 GΩ 20 GΩ to 200 GΩ >200 GΩ	unspecified 5 % 20 % unspecified
2500 V	<200 kΩ 200 kΩ to 50 GΩ 50 GΩ to 500 GΩ >500 GΩ	unspecified 5 % 20 % unspecified
5000 V	<200 kΩ 200 kΩ to 100 GΩ 100 GΩ to 1 TΩ >1 TΩ	unspecified 5 % 20 % unspecified
Bar graph range:		0 to 1 TΩ
Insulation test voltage accuracy:		-0 %, +10 % at 1 mA load current
Induced ac mains current rejection:		2 mA maximum
Charging rate for capacitive load:		5 seconds per μF
Discharge rate for capacitive load		1.5 s/μF
Leakage current measurement		
Range	Accuracy	
1 nA to 2 mA	+/- (5 % + 2 nA)	
Capacitive measurement		
Range	Accuracy	
0.01 μF to 15.00 μF	+/- (15 % of reading + 0.03 μF)	
Timer		
Range	Resolution	
0 to 99 minutes	Setting: 1 minute Indication: 1 second	
Live circuit warning	Warning range: 30 V to 660 V ac/dc, 50/60 Hz Voltage accuracy: +/- (5 % + 2 V)	

Warranty in Other Languages

LIMITES DE GARANTIE ET DE RESPONSABILITE (French)

La société Fluke garantit l'absence de vices de matériaux et de fabrication de ses produits dans des conditions normales d'utilisation et d'entretien. La période de garantie est de 2 ans et prend effet à la date d'expédition. Les pièces, les réparations de produit et les services sont garantis pour une période de 90 jours. Cette garantie ne s'applique qu'à l'acheteur d'origine ou à l'utilisateur final s'il est client d'un distributeur agréé par Fluke, et ne s'applique pas aux fusibles, aux batteries/piles interchangeables ni à aucun produit qui, de l'avis de Fluke, a été malmené, modifié, négligé, contaminé ou endommagé par accident ou soumis à des conditions anormales d'utilisation et de manipulation. Fluke garantit que le logiciel fonctionnera en grande partie conformément à ses spécifications fonctionnelles pour une période de 90 jours et qu'il a été correctement enregistré sur des supports non défectueux. Fluke ne garantit pas que le logiciel ne contient pas d'erreurs ou qu'il fonctionne sans interruption.

Les distributeurs agréés par Fluke appliqueront cette garantie à des produits vendus à leurs clients neufs et qui n'ont pas servi mais ne sont pas autorisés à appliquer une garantie plus étendue ou différente au nom de Fluke. Le support de garantie est offert uniquement si le produit a été acquis par l'intermédiaire d'un point de vente agréé par Fluke ou bien si l'acheteur a payé le prix international applicable. Fluke se réserve le droit de facturer à l'acheteur les frais d'importation des pièces de réparation ou de remplacement si le produit acheté dans un pays a été expédié dans un autre pays pour y être réparé.

L'obligation de garantie de Fluke est limitée, au choix de Fluke, au remboursement du prix d'achat, ou à la réparation/remplacement gratuit d'un produit défectueux retourné dans le délai de garantie à un centre de service agréé par Fluke. Pour avoir recours au service de la garantie, mettez-vous en rapport avec le centre de service agréé Fluke le plus proche pour recevoir les références d'autorisation de renvoi, ou envoyez le produit, accompagné d'une description du problème, port et assurance payés (franco lieu de destination), à ce centre de service. Fluke dégage toute responsabilité en cas de dégradations survenues au cours du transport. Après la réparation sous garantie, le produit sera retourné à l'acheteur, frais de port payés d'avance (franco lieu de destination). Si Fluke estime que le problème est le résultat d'une négligence, d'un traitement abusif, d'une contamination, d'une modification, d'un accident ou de conditions de fonctionnement ou de manipulation anormales, notamment de surtensions liées à une utilisation du produit en dehors des spécifications nominales, ou de l'usure normale des composants mécaniques, Fluke fournira un devis des frais de réparation et ne commencera la réparation qu'après en avoir reçu l'autorisation. Après la réparation, le produit sera retourné à l'acheteur, frais de port payés d'avance, et les frais de réparation et de transport lui seront facturés.

LA PRÉSENTE GARANTIE EST EXCLUSIVE ET TIENT LIEU DE TOUTES AUTRES GARANTIES, EXPLICITES OU IMPLICITES, Y COMPRIS, MAIS NON EXCLUSIVEMENT, TOUTE GARANTIE IMPLICITE QUANT À L'APTITUDE DU PRODUIT À ÊTRE COMMERCIALISÉ OU À ÊTRE APPLIQUÉ À UNE FIN OU À UN USAGE DÉTERMINÉ. FLUKE NE POURRA ÊTRE TENU RESPONSABLE D'AUCUN DOMMAGE PARTICULIER, INDIRECT, ACCIDENTEL OU CONSÉCUTIF, NI D'AUCUNS DÉGÂTS OU PERTES, DE DONNÉES NOTAMMENT, SUR UNE BASE CONTRACTUELLE, EXTRA-CONTRACTUELLE OU AUTRE.

Étant donné que certains pays ou états n'admettent pas les limitations d'une condition de garantie implicite, ou l'exclusion ou la limitation de dégâts accidentels ou consécutifs, il se peut que les limitations et les exclusions de cette garantie ne s'appliquent pas à chaque acheteur. Si une disposition quelconque de cette garantie est jugée non valide ou inapplicable par un tribunal ou un autre pouvoir décisionnel compétent, une telle décision n'affectera en rien la validité ou le caractère exécutoire de toute autre disposition.

GARANZIA LIMITATA & LIMITAZIONE DI RESPONSABILITÀ (Italian)

Ogni prodotto Fluke è garantito come esente da difetti nei materiali e nella manodopera per normali situazioni di uso. Il periodo di garanzia è di 2 anni a partire dalla data di spedizione. La garanzia per le parti sostituite, le riparazioni e l'assistenza è di 90 giorni. La garanzia è emessa solo a beneficio dell'acquirente originale o del consumatore finale che abbia acquistato il prodotto da un rivenditore Fluke autorizzato. Non copre fusibili, pile di ricambio e qualsiasi apparecchio che, a giudizio della Fluke, sia stato adoperato in modo improprio, modificato, trascurato o danneggiato sia accidentalmente che a causa di condizioni anormale d'uso e manipolazione. La Fluke garantisce per 90 giorni che il software funzionerà sostanzialmente secondo le proprie specifiche operative e che sia stato registrato su supporti non difettosi. Non garantisce che il software sarà esente da errori o che funzionerà senza interruzioni.

I rivenditori autorizzati Fluke sono tenuti ad estendere la presente garanzia per prodotti nuovi e non ancora usati a beneficio esclusivo degli utenti finali, ma non sono autorizzati a emettere una garanzia diversa o più ampia a nome della Fluke. La garanzia è valida solo se il prodotto è stato acquistato attraverso la rete commerciale Fluke o se l'acquirente ha pagato il prezzo non scontato. La Fluke si riserva il diritto di fatturare all'acquirente i costi di importazione dei ricambi per la riparazione/sostituzione eseguita, nel caso in cui il prodotto acquistato in un Paese sia sottoposto a riparazione in un altro.

L'obbligo di garanzia è limitato, a discrezione della Fluke, al rimborso del prezzo d'acquisto, alla riparazione gratuita o alla sostituzione di un prodotto difettoso che sia inviato ad un centro assistenza autorizzato Fluke entro il periodo di garanzia. Per usufruire dell'assistenza in garanzia, rivolgersi al più vicino centro assistenza autorizzato Fluke per ottenere informazioni sull'autorizzazione al reso. Quindi spedire il prodotto al centro di assistenza. Il prodotto deve essere accompagnato da una descrizione dei problemi riscontrati, e deve essere spedito in porto franco e con assicurazione pre-pagata. La Fluke declina ogni responsabilità per danni in transito. A seguito delle riparazioni in garanzia, il prodotto sarà restituito all'acquirente in porto franco. Se la Fluke accerta che il guasto sia stato causato da negligenza, uso improprio, contaminazione, alterazione, incidente o condizioni anormale di uso e manipolazione (comprese le sovratensioni causate dall'uso dello strumento oltre la propria portata nominale e l'usura dei componenti meccanici dovuta all'uso normale dello strumento), la Fluke presenterà una stima dei costi di riparazione e attenderà l'autorizzazione dell'utente a procedere alla riparazione. In seguito alla riparazione, il prodotto sarà restituito all'acquirente con addebito delle spese di riparazione e di spedizione.

LA PRESENTE GARANZIA È L'UNICO ED ESCLUSIVO RICORSO DISPONIBILE ALL'ACQUIRENTE ED È EMESSA IN SOSTITUZIONE DI OGNI ALTRA GARANZIA, ESPRESSA OD IMPLICITA, COMPRESA, MA NON LIMITATA AD ESSA, QUALSIASI GARANZIA IMPLICITA DI COMMERCIALITÀ O DI IDONEITÀ PER USI PARTICOLARI. LA FLUKE DECLINA OGNI RESPONSABILITÀ PER DANNI O PERDITE PARTICOLARI, INDIRETTI, INCIDENTALI O CONSEGUENTI, COMPRESA LA PERDITA DI DATI DOVUTI A QUALSIASI CAUSA O TEORIA.

Poiché alcuni Paesi non consentono di limitare i termini di una garanzia implicita né l'esclusione o la limitazione di danni accidentali o sequenziali, le limitazioni e le esclusioni della presente garanzia possono non valere per tutti gli acquirenti. Se una clausola qualsiasi della presente garanzia non è ritenuta valida o attuabile dal tribunale o altro foro competente, tale giudizio non avrà effetto sulla validità delle altre clausole.

Fluke Corporation
P.O. Box 9090
Everett, WA 98206-9090
USA

Fluke Europe B.V.
P.O. Box 1186
NL-5602 BD Eindhoven
Holland

BEGRENZTE GEWÄHRLEISTUNG UND HAFTUNGSBESCHRÄNKUNG (German)

Fluke gewährleistet, daß jedes Fluke-Produkt unter normalem Gebrauch und Service frei von Material- und Fertigungsdefekten ist. Die Garantiedauer beträgt 2 Jahre ab Versanddatum. Die Garantiedauer für Teile, Produktreparaturen und Service beträgt 90 Tage. Diese Garantie wird ausschließlich dem Ersterwerber bzw. dem Endverbraucher geleistet, der das betreffende Produkt von einer von Fluke autorisierten Verkaufsstelle erworben hat, und erstreckt sich nicht auf Sicherungen, Einwegbatterien oder andere Produkte, die nach dem Eressen von Fluke unsachgemäß verwendet, verändert, verschmutzt, vernachlässigt, durch Unfälle beschädigt oder abnormalen Betriebsbedingungen oder einer unsachgemäßen Handhabung ausgesetzt wurden. Fluke garantiert für einen Zeitraum von 90 Tagen, daß die Software im wesentlichen in Übereinstimmung mit den einschlägigen Funktionsbeschreibungen funktioniert und daß diese Software auf fehlerfreien Datenträgern gespeichert wurde. Fluke übernimmt jedoch keine Garantie dafür, daß die Software fehlerfrei ist und störungsfrei arbeitet.

Von Fluke autorisierte Verkaufsstellen werden diese Garantie ausschließlich für neue und nicht benutzte, an Endverbraucher verkaufte Produkte leisten. Die Verkaufsstellen sind jedoch nicht dazu berechtigt, diese Garantie im Namen von Fluke zu verlängern, auszudehnen oder in irgendeiner anderen Weise abzuändern. Der Erwerber hat nur dann das Recht, aus der Garantie abgeleitete Unterstützungsleistungen in Anspruch zu nehmen, wenn er das Produkt bei einer von Fluke autorisierten Vertriebsstelle gekauft oder den jeweils geltenden internationalen Preis gezahlt hat. Fluke behält sich das Recht vor, dem Erwerber Einfuhrgebühren für Ersatzteile in Rechnung zu stellen, wenn dieser das Produkt in einem anderen Land zur Reparatur anbietet, als dem Land, in dem er das Produkt ursprünglich erworben hat. Flukes Garantieverpflichtung beschränkt sich darauf, daß Fluke nach eigenem Eressen den Kaufpreis ersetzt oder aber das defekte Produkt unentgeltlich repariert oder austauscht, wenn dieses Produkt innerhalb der Garantiefrist einem von Fluke autorisierten Servicezentrum zur Reparatur übergeben wird.

Um die Garantieleistung in Anspruch zu nehmen, wenden Sie sich bitte an das nächstgelegene und von Fluke autorisierte Servicezentrum, um Rücknahmeinformationen zu erhalten, und senden Sie dann das Produkt mit einer Beschreibung des Problems und unter Vorauszahlung von Fracht- und Versicherungskosten (FOB Bestimmungsart) an das nächstgelegene und von Fluke autorisierte Servicezentrum. Fluke übernimmt keine Haftung für Transportkosten. Im Anschluß an die Reparatur wird das Produkt unter Vorauszahlung von Frachtkosten (FOB Bestimmungsart) an den Erwerber zurückgeschickt. Wenn Fluke jedoch feststellt, daß der Defekt auf Vernachlässigung, unsachgemäße Handhabung, Verschmutzung, Veränderungen am Gerät, einen Unfall oder auf anormale Betriebsbedingungen, einschließlich durch außerhalb der für das Produkt spezifizierten Belastbarkeit verursachten Überspannungsfehlern, zurückzuführen ist, wird Fluke dem Erwerber einen Voranschlag der Reparaturkosten zumachen lassen und erst die Zustimmung des Erwerbers einholen, bevor die Arbeiten begonnen werden. Nach der Reparatur wird das Produkt unter Vorauszahlung der Frachtkosten an den Erwerber zurückgeschickt, und es werden dem Erwerber die Reparaturkosten und die Versandkosten (FOB Versandort) in Rechnung gestellt.

DIE VORSTEHENDEN GARANTIEBESTIMMUNGEN STELLEN DEN EINZIGEN UND ALLEINIGEN RECHTSANSPRUCH AUF SCHADENERSATZ DES ERWERBERS DAR UND GELTEN AUSSCHLIESSLICH UND AN STELLE VON ALLEN ANDEREN VERTRAGLICHEN ODER GESETZLICHEN GEWÄHRLEISTUNGSPFLICHTEN, EINSCHLIESSLICH - JEDOCH NICHT DARAUFGEBESCHRÄNKT - DER GESETZLICHEN GEWÄHRLEISTUNG DER MARKTFÄHIGKEIT, DER GEBRAUCHSEIGNUNG UND DER ZWECKDIEHLICHKEIT FÜR EINEN BESTIMMTEN EINSATZ. FLUKE HAFTET NICHT FÜR SPEZIELLE, UNMITTELBARE, MITTELBARE, BEGLEIT- ODER FOLGESCHÄDEN ODER VERLUSTE, EINSCHLIESSLICH VERLUST VON DATEN, UNABHÄNGIG VON DER URSACHE ODER THEORIE.

Angesichts der Tatsache, daß in einigen Ländern die Begrenzung einer gesetzlichen Gewährleistung sowie der Ausschluß oder die Begrenzung von Begleit- oder Folgeschäden nicht zulässig ist, kann es sein, daß die obengenannten Einschränkungen und Ausschlüsse nicht für jeden Erwerber gelten. Sollte eine Klausel dieser Garantiebestimmungen von einem zuständigen Gericht oder einer anderen Entscheidungsinstanz für unwirksam oder nicht durchsetzbar befunden werden, so bleiben die Wirksamkeit oder Durchsetzbarkeit irgendeiner anderen Klausel dieser Garantiebestimmungen von einem solchen Spruch unberührt.

GARANTÍA LIMITADA Y LIMITACIÓN DE RESPONSABILIDAD (Spanish)

Se garantiza que todo producto de Fluke no tendrá defectos en los materiales ni en la mano de obra en condiciones normales de utilización y mantenimiento. El periodo de garantía es de 2 años y comienza en la fecha de despacho. Las piezas de repuesto, reparaciones y servicios son garantizados por 90 días. Esta garantía se extiende sólo al comprador original o al cliente final de un revendedor autorizado por Fluke y no es válida para fusibles, baterías desechables o productos que, en opinión de Fluke, hayan sido utilizados incorrectamente, modificados, maltratados, contaminados o dañados ya sea accidentalmente o a causa de condiciones de funcionamiento o manejo anormales. Fluke garantiza que el software funcionará substancialmente de acuerdo con sus especificaciones funcionales durante 90 días y que ha sido grabado correctamente en un medio magnético sin defectos. Fluke no garantiza que el software no tendrá errores ni que operará sin interrupción.

Los revendedores autorizados por Fluke podrán extender esta garantía solamente a los Compradores finales de productos nuevos y sin uso previo, pero carecen de autoridad para extender una garantía mayor o diferente en nombre de Fluke. La asistencia técnica en garantía estará disponible únicamente si el producto fue comprado a través de un centro de distribución autorizado por Fluke o si el comprador pagó el precio internacional correspondiente. Fluke se reserva el derecho a facturar al Comprador los costos de importación de reparaciones/repuestos cuando el producto comprado en un país es enviado a reparación a otro país.

La obligación de Fluke de acuerdo con la garantía está limitada, a discreción de Fluke, al reembolso del precio de compra, reparación gratuita o al reemplazo de un producto defectuoso que es devuelto a un centro de servicio autorizado por Fluke dentro del periodo de garantía. Para obtener el servicio de la garantía, comuníquese con el centro de servicio autorizado por Fluke más cercano a usted, solicite la información correspondiente a la autorización de la devolución y luego envíe el producto a dicho centro de servicio con una descripción del fallo y los portes y el seguro prepagados (FOB destino). Fluke no asume ningún riesgo por daño durante el tránsito. Después de la reparación de garantía, el producto será devuelto al Comprador, con los fletes prepagados (FOB destino). Si Fluke determina que el fallo fue causado por maltrato, mala utilización, contaminación, modificación o por una condición accidental o anormal presentada durante el funcionamiento o manejo, incluidos los fallos por sobretensión causados por el uso fuera de los valores nominales especificados para el producto, o por el desgaste normal de los componentes mecánicos, Fluke preparará una estimación de los costos de reparación y obtendrá su autorización antes de comenzar el trabajo. Al concluir la reparación, el producto será devuelto al Comprador con los fletes prepagados y al Comprador le serán facturados la reparación y los costos de transporte (FOB en el sitio de despacho).

ESTA GARANTÍA ES EL ÚNICO Y EXCLUSIVO RECURSO DEL COMPRADOR Y SUBSTITUYE A TODAS LAS OTRAS GARANTÍAS, EXPRESAS O IMPLÍCITAS, INCLUYENDO, PERO SIN LIMITARSE A, TODA GARANTÍA IMPLÍCITA DE COMERCIABILIDAD O IDONEIDAD PARA UN PROPÓSITO DETERMINADO. FLUKE NO SE RESPONSABILIZA DE PÉRDIDAS NI DAÑOS ESPECIALES, INDIRECTOS, IMPREVISTOS O CONTINGENTES, INCLUIDA LA PÉRDIDA DE DATOS, QUE SURJAN POR CUALQUIER TIPO DE CAUSA O TEORÍA. Como algunos países o estados no permiten la limitación de los términos de una garantía implícita, ni la exclusión ni limitación de daños incidentales o consecuentes, las limitaciones y exclusiones de esta garantía pueden no ser válidas para todos los Compradores. Si una cláusula de esta Garantía es considerada inválida o inaplicable por un tribunal o por algún otro ente de jurisdicción competente y responsable de la toma de decisiones, dicha consideración no afectará la validez o aplicabilidad de cualquier otra cláusula.

Fluke Corporation
P.O. Box 9090
Everett, WA 98206-9090
USA

Fluke Europe B.V.
P.O. Box 1186
NL-5602 BD Eindhoven
Holland

GARANTIA LIMITADA E LIMITAÇÃO DE RESPONSABILIDADE (Portuguese)

Todos os produtos da Fluke são garantidos contra defeitos de material ou fabricação, sob circunstâncias normais de uso e manutenção. O período de garantia é de 2 anos, a partir da data da remessa. As peças, reparos e serviços são garantidos por 90 dias. Esta garantia se aplica apenas ao comprador original, ou ao cliente usuário-final de um revendedor autorizado da Fluke, e não cobre fusíveis, baterias descartáveis, nem qualquer produto que, na opinião da Fluke, tenha sido usado de forma inadequada, alterado, tenha recebido manutenção inadequada ou tenha sido danificado por acidente ou condições anormais de operação ou manuseio. A Fluke garante que o software funcionará de acordo com as suas especificações técnicas pelo período de 90 dias, e que foi gravado de forma adequada em meio físico sem defeitos. A Fluke não garante que o software esteja livre de defeitos, nem que funcionará sem interrupções.

Os vendedores autorizados da Fluke fornecerão esta garantia de produtos novos e não usados apenas a clientes usuários finais, mas não têm qualquer autoridade para fornecer, em nome da Fluke, uma garantia mais ampla ou diferente da presente. A assistência técnica coberta pela garantia está disponível se o produto houver sido adquirido de uma loja autorizada da Fluke, ou se o Comprador tiver pago o preço internacional aplicável. A Fluke se reserva o direito de cobrar do Comprador taxas relativa a custos de importação referentes a peças de substituição/reparos quando o produto for comprado em um país e submetido para reparos em um outro país.

As obrigações da Fluke pertinentes a esta garantia são limitadas, a critério da Fluke, à devolução da importância correspondente ao preço pago pela compra do produto, reparos gratuitos, ou substituição de um produto defeituoso que seja devolvido a um centro autorizado de reparos da Fluke dentro do período coberto pela garantia.

Para obter serviços cobertos pela garantia, entre em contato com o centro autorizado de reparos da Fluke mais próximo para obter informações sobre autorizações de retorno e então, envie o produto para o centro autorizado, com uma descrição do problema encontrado e com frete e seguro já pagos (FOB no destino), ao centro autorizado de reparos mais próximo. A Fluke não se responsabiliza por nenhum dano que possa ocorrer durante o transporte. Após serem efetuados os serviços cobertos pela garantia, o produto será devolvido ao Comprador, com frete já pago (FOB no destino). Se a Fluke constatar que a falha do produto foi causada por uso inadequado, contaminação, alterações, acidente, ou condições anormais de operação ou manuseio, inclusive falhas devidas a sobretensão causadas pelo uso do produto fora das faixas e classificações especificadas, ou pelo desgaste normal de componentes mecânicos, a Fluke dará uma estimativa dos custos de reparo, e obterá autorização do cliente antes de começar os reparos. Após a realização dos reparos, o produto será devolvido ao Comprador com frete já pago e este reembolsará a Fluke pelos custos dos reparos e do transporte de retorno (FOB no local de remessa).

ESTA GARANTIA É O ÚNICO E EXCLUSIVO RECURSO JURÍDICO DO COMPRADOR, E SUBSTITUI TODAS AS OUTRAS GARANTIAS, EXPRESSAS OU IMPLÍCITAS, INCLUINDO, MAS NÃO SE LIMITANDO A, QUALQUER GARANTIA IMPLÍCITA DE COMERCIALIZAÇÃO OU ADEQUAÇÃO PARA UM DETERMINADO FIM. A FLUKE NÃO SE RESPONSABILIZA POR NENHUM DANO OU PERDA, INCIDENTAL OU CONSEQUENTE, QUE POSSA OCORRER POR QUALQUER MOTIVO OU QUE SEJA DECORRENTE DE QUALQUER CAUSA OR TEORIA JURÍDICA.

Como alguns estados ou países não permitem a exclusão ou limitação de uma garantia implícita nem de danos incidentais ou consequentes, esta limitação de responsabilidade pode não ser aplicável no seu caso. Se uma corte qualificada de jurisdição considerar qualquer provisão desta garantia inválida ou não-executável, tal decisão judicial não afetará a validade ou executabilidade de qualquer outra provisão.

GARANTI (Danish)

Fluke garanterer dette produkt mod materiale- og fabriktionsfejl ved normal brug og vedligeholdelse i 2 år fra afsendelsesdatoen. Dele, reparationer og service garanteres i 90 dage. Garantien gælder kun den oprindelige detailkunde som har købt hos en autoriseret Fluke-forhandler og omfatter hverken sikringer, engangs batterier eller produkter der efter Flukes skøn er blevet misbrugt, modificeret, skadet ved skødesløshed og uheld og ved unormale driftsforhold og håndtering. Fluke garanterer at software fungerer i alt væsentligt som beskrevet i 90 dage, og at den er korrekt indlæst på medier uden defekter; men Fluke garanterer ikke at software fungerer fejlfrit og uafbrudt.

Autoriserede Fluke-forhandlere skal udstede nærværende garanti på ny og ubrugte produkter til detailkunden, men er ikke bemyndiget til at udvide eller ændre garantien på Flukes vegne. Garantiservice ydes kun dersom produktet er købt hos en autoriseret Fluke-forhandler eller dersom køberen har betalt gældende international pris for det. Fluke forbeholder sig ret til at opkræve kunden evt. told- og importafgifter på reparation og ombytningsdele forbundet med indsendelse af et produkt købt i et, men indsendt til reparation i et andet land.

Flukes garanti er begrænset til efter eget skøn enten refundering af købspris, vederlagsfri reparation eller ombytning af et defekt produkt indsendt til reparation til et autoriseret servicecenter inden for garantiperioden.

Service iht. garantien fås ved henvendelse til nærmeste autoriserede Fluke-servicecenter efter returneringsgodkendelse og påfølgende indsendelse af produktet med beskrivelse af defekten til det servicecenter med porto og forsikring forudbetalt (FOB modtager). Fluke påtager sig intet ansvar for forsendelsesskader. Efter reparation iht. garantien returneres produktet til kunden med porto betalt (FOB modtager). Dersom Fluke finder at fejl skyldes misbrug, modificering, uheld eller unormale driftsforhold og behandling, herunder fejl pga. overbelastning fordi instrumentet er blevet brugt under forhold ud over dets nomerede driftsområde, eller mekaniske deles normale slitage, giver Fluke et overslag på reparation og indhenter samtykke hertil, inden arbejdet udføres. Efter reparation returneres produktet til kunden med portoen betalt, og kunden får regning for reparation og returneringsomkostninger (FOB afsender).

DENNE GARANTI ER KØBERENS ENESTE RETSMIDDEL, OG DER GIVES INGEN ANDEN, HVERKEN UDRYKKELIG ELLER UNDERFORSTÅET, GARANTI, SÅSOM FOR SALGBARHED OG ANVENDELIGHED TIL GIVNE FORMÅL. FLUKE HAR INGEN ERSTATNINGSPLIKT FOR SÆRLIGE, INDIREKTE, TILFÆLDIGE OG FØLGESKADER OG TAB, HERUNDER DATATAB, UANSET PÅ HVILET GRUNDLAG ELLER RETSTOLKNING DE REJSES.

Da tidsbegrænsning af underforstået garanti, og erstatningspligtsfraskrivelse for tilfældige skader og følgeskader ikke anerkendes i visse lande og stater, gælder ovenstående garantibetingelser muligvis ikke alle kunder. Dersom en givet betingelse i nærværende garanti bliver kendt ugyldig eller uden hævd af retsinstans eller anden kyndig med kompetent jurisdiktion, får sådan kendelse ingen indflydelse på de øvrige garantibetingelsers gyldighed og hævd.

Fluke Corporation
P.O. Box 9090
Everett, WA 98206-9090
USA

Fluke Europe B.V.
P.O. Box 1186
NL-5602 BD Eindhoven
Holland

BEPERKTE GARANTIE EN BEPERKING VAN AANSPRAKELIJKHEID (Dutch)

Fluke garandeert voor elk van haar producten, dat het bij normaal gebruik en onderhoud vrij is van materiaal- en fabricagefouten. De garantieperiode bedraagt 2 jaar en gaat in op de datum van verzending. De garantie op onderdelen en op de reparatie en het onderhoud van producten geldt 90 dagen. Deze garantie geldt alleen voor de eerste koper of de eindgebruiker die het product heeft aangeschaft bij een door Fluke erkend wederverkoper, en is niet van toepassing op zekeringen, gewegverbatterijen of enig ander product dat, naar de mening van Fluke, verkeerd gebruikt, gewijzigd, verwaarloosd of verontreinigd is, of beschadigd is door een ongeluk of door abnormale bedienings- of behandelingsomstandigheden. Fluke garandeert dat de software gedurende 90 dagen in hoofdzaak in overeenstemming met de functionele specificaties zal functioneren en dat de software op de juiste wijze op niet-defecte dragers is vastgelegd. Fluke garandeert niet dat de software vrij is van fouten of zonder onderbreking werkt. Door Fluke erkende wederverkopers verstreken deze garantie uitsluitend aan eindgebruikers op nieuwe en ongebruikte producten, maar ze zijn niet gemachtigd om deze garantie namens Fluke uit te breiden of te wijzigen. Garantieservice is uitsluitend beschikbaar als het product is aangeschaft via een door Fluke erkend verkooppunt of wanneer de koper de toepasbare internationale prijs heeft betaald. Fluke behoudt zich het recht voor de koper de invoerkosten voor de reparatie-/vervangingsonderdelen in rekening te brengen als het product in een ander land dan het land van aankoop ter reparatie wordt aangeboden.

De garantieverplichting van Fluke beperkt zich, naar goeddunken van Fluke, tot het terugbetalen van de aankoopprijs, het kosteloos repareren of vervangen van een defect product dat binnen de garantieperiode aan een door Fluke erkend service-centrum wordt geretourneerd.

Voor garantieservice vraagt u bij het dichtsbijzijnde door Fluke erkende service-centrum om een retourautorisatienummer en stuurt u het product vervolgens samen met een beschrijving van het probleem franco en met de verzekering vooruitbetaald (FOB bestemming) naar dat centrum. Fluke is niet aansprakelijk voor beschadiging die tijdens het vervoer wordt opgelopen. Nadat het product is gerepareerd op grond van de garantie, zal het aan de koper worden geretourneerd met vervoerkosten vooruitbetaald (FOB bestemming). Als Fluke van oordeel is dat het defect is veroorzaakt door verwaarlozing, verkeerd gebruik, verontreiniging, wijziging, ongeluk of abnormale bedienings- of behandelingsomstandigheden, met inbegrip van overspanningsdefecten die te wijten zijn aan gebruik buiten de opgegeven nominale waarden voor het product of buiten de normale slijtage van de mechanische componenten, zal Fluke een prijsopgave van de reparatiekosten opstellen en niet zonder toestemming aan de werkzaamheden beginnen. Na de reparatie zal het product aan de koper worden geretourneerd met vervoerkosten vooruitbetaald en zullen de reparatie- en retourkosten (FOB afzender) aan de koper in rekening worden gebracht.

DEZE GARANTIE IS HET ENIGE EN EXCLUSIEVE VERHAAL VAN DE KOPER EN VERVANGT ALLE ANDERE UITDRUKKELIJKE OF STILZWIJGENDE GARANTIES, MET INBEGRIJF VAN, MAAR NIET BEPERKT TOT STILZWIJGENDE GARANTIES VAN VERKOOPBAARHEID OF GESCHIKTHEID VOOR EEN BEPAALD DOEL. FLUKE IS NIET AANSPRAKELIJK VOOR BIJZONDERE SCHADE, INDIRECTE SCHADE, INCIDENTELE SCHADE OF GEVOLGSCHADE, MET INBEGRIJF VAN VERLIES VAN GEGEVENS, VOORTVLOEIENDE UIT WELKE OORZAAK OF THEORIE DAN OK.

Aangezien in bepaalde landen de staten de beperking van de geldigheidsduur van een stilzwijgende garantie of de uitsluiting of beperking van incidentele schade of gevolgschade niet is toegestaan, is het mogelijk dat de beperkingen en uitsluitingen van deze garantie niet van toepassing zijn op elke koper. Wanneer een van de voorwaarden van deze garantie door een bevoegde rechtbank of een andere bevoegde beleidsvormer ongeldig of niet-afdwingbaar wordt verklaard, heeft dit geen consequenties voor de geldigheid of afdwingbaarheid van enige andere voorwaarde van deze garantie.

RAJOITETTU TAKUU & VASTUUN RAJOITUKSET (Finnish)

Fluke takaa jokaisen tuotteen materiaali- ja työvikojen varalta normaalissa käytössä. Takuuauka on 2 vuotta ja se alkaa toimituksesta tahtaalta. Varaosat, korjaukset ja huolto taataan 90 päivän ajan. Tämä takuu koskee ainoastaan alkuperäistä ostajaa tai valtuutetun Fluke-jälleenmyyjän loppuasiakasta. Takuu ei koske sulaketta, vaihdettavia paristoja tai laitteita, joita Fluken tulkinnan mukaan on kohdeltu kaltoin, muutettu, laiminlyöty tai ne ovat vaurioituneet onnettomuudessa tai epätavallisissa oloissa tai käsittelyssä. Fluke takaa, että laitteissa olevat ohjelmistot toimivat pääsääntöisesti oikein 90 päivän ajan ja että ohjelmistot on tallioitu ehjille tallennusvälineille. Fluke ei takaa, että ohjelmistot olisivat virheettömiä tai että ne toimisivat katkoitta. Fluken valtuuttamat jälleenmyyjät saavat siirtää tämän takuun uuden tuotteen osalta loppuasiakkaalle, mutta jälleenmyyjillä ei ole valtuutusta antaa laajempaa tai erilaista takuuta. Takuuutuki annetaan tuotteille, jotka on ostettu Fluken valtuuttamalta jälleenmyyjältä tai joista ostaja on maksanut kansainvälisesti käyvän hinnan. Jos tuote on ostettu toisessa maassa kun missä se tuodaan korjattavaksi, Fluke pidättää itsellään oikeuden laskuttaa ostajalta kuljetuskustannukset ja korjaus/varaosakustannukset. Fluken takuuvastuu rajoittuu (Fluken valinnan mukaan) tuotteen kaupprehinnan palauttamiseen, tuotteen veloitusettomaan korjaamiseen tai tuotteen vaihtamiseen uuteen, jos viallinen tuote on palautettu Fluken valtuuttamaan huoltoilikeeseen takuuajan sisällä.

Ota takuuhuoltokysymyksissä yhteyttä lähimpään valtuutettuun Fluke-huoltopisteeseen saadaksesi palautusoiheutta koskevat ohjeet ja lähetä sitten tuote kyseiseen huoltopisteeseen ongelman kuvauksen kera, posti- ja vakuutuskulut maksettuna (FOB määränpäät). Fluke ei ota vastuuta kuljetuksen aikana sattuneista vaurioista. Takuukorjauksen jälkeen tuote palautetaan ostajalle kuljetuskulut maksettuna (FOB määränpäät). Jos Fluke toteaa vian johtuneen laiminlyönnistä, väärinkäytöstä, likaantumisesta, muutoksista, onnettomuudesta tai epätavallisista oloista tai käsittelyistä, mukaan lukien käyttäjän aiheuttamat vlijänniteviat, jotka ovat aiheutuneet laitteen käytöstä sen teknisten erittelyjen vastaisesti, tai mekaanisten komponenttien normaalista kulumisesta, Fluke antaa arvion korjauskustannuksista ja odottaa asiakkaan valtuutusta ennen töiden aloittamista. Korjauksen jälkeen tuote palautetaan ostajalle kuljetuskustannukset maksettuna, ja ostajaa laskutetaan korjauksesta ja paluukuljetuskustannuksista (FOB lastauspaikka).

TÄMÄ TAKUU ON OSTAJAN AINOAA YKSINOMAINEN KEINO. EI OLE OLEMASSA MITÄÄN MUITA VÄLITTTÖMIÄ TAI VÄLILLISIÄ TAKUITA, KUTEN TAKUITA KAUPPATAVUUDESTA TAI SOPIVUUDESTA TIETTYYN TARKOITUKSEEN. FLUKE EI OLE KORVAUSVELVOLLINEN MISTÄÄN ERITYISISTÄ, EPÄSUORISTA, SATUNNAISISTA TAI SEURAAMUKSELLISISTA VAHINGOISTA TAI TAPPIOISTA, MUKAAN LUKIEN TIETOJEN KATOAMINEN, PERUSTUIVAT NE SITTEN MIHIN TAHANSA SYHYHN TAI TEORIAAN.

Joissain maissa väillisten takuiden rajoitus tai epäminen sekä väillisten tai johdannaisen vahinkojen korvausvelvollisuuden epäminen ei ole sallittua. Nämä valmistajan vastuun rajoitukset eivät siis välttämättä koske Sinua. Jos paikallinen oikeuslaitos pitää tämän takuun jotain osaa lainvastaisena tai toimeenpanokelvottomana, tällainen tulkitaan ei vaikuta takuun muiden osien laillisuuteen tai toimeenpanokelpoisuuteen.

Fluke Corporation
P.O. Box 9090
Everett, WA 98206-9090
USA

Fluke Europe B.V.
P.O. Box 1186
NL-5602 BD Eindhoven
Holland

BEGRENSET GARANTI OG ANSVARSBEGRENSNING (Norwegian)

Hvert Fluke-produkt er garantert uten defekter i materiale og utførelse ved normal bruk og anvendelse. Garantien gjelder i 2 år fra foresendelsesdatoen. Deler, reparasjoner av produktet og service er garantert i 90 dager. Denne garantien gjelder bare for opprinnelig kjøper eller forbruker som har kjøpt produktet hos en autorisert Fluke-forhandler, og gjelder ikke for sikringer, utskiftbare batterier eller for noen produkter, som etter Flukes vurdering, er misbrukt, endret, vanskjøttet, kontaminert eller ødelagt ved uhell eller unormale drifts- eller håndteringsforhold. Fluke garanterer at programvaren vil fungere tilfredsstillende i henhold til sine funksjonelle spesifikasjoner i 90 dager, og at det er riktig innspilt på kurant medium. Fluke garanterer ikke at programvaren er feilfri eller fungerer uten avbrudd. Autoriserte Fluke-forhandlere skal bare utvide denne garantien på nye og ubrukte produkter til forbrukere, men har ingen myndighet til å gi en mer omfattende eller forskjellig garanti på vegne av Fluke. Garantistotte er bare tilgjengelig hvis produktet kjøpes gjennom et autorisert Fluke-utsalgs- eller kjøper som betalt pålydende internasjonale pris. Fluke reserverer seg retten til å fakturere kjøperen for importkostnader av reservedeler når produktet, som er kjøpt i ett land, leveres inn til reparasjon i et annet land.

Flukes garantiforpliktelser er begrenset til, etter Flukes valg, å refundere kjøpeprisen, reparere gratis eller erstatte et defekt produkt som returneres til et autorisert Fluke-servicesenter innenfor garantiperioden. Garantisevice oppnås ved å ta kontakt med nærmeste autoriserte Fluke-servicesenter for å få informasjon om returgodkjenning, og send deretter produktet til det aktuelle servicesenteret med en beskrivelse av problemet, med frakt og forsikring betalt (FOB bestemmelsesstedet). Fluke påtar seg intet ansvar for transportskader. Etter reparasjon under garantien, returneres produktet til kjøperen, med frakt betalt (FOB bestemmelsesstedet). Hvis Fluke finner ut at feilen skyldtes vanskjøtsel, misbruk, kontaminering, endring, ulykke eller unormal driftsforhold eller håndtering, inkludert overspenningsfeil som følge av ikke-klassifisert bruk av enheten, eller normal slitasje på mekaniske komponenter, vil Fluke gi et overslag over reparasjonskostnadene og innhente godkjenning før arbeidet påbegynnes. Etter eventuell reparasjon under garantien, returneres produktet til kjøperen, med frakt betalt, og kjøperen får regning på reparasjonen og returfrakten (FOB leveringssted). DENNE GARANTIE ER KUNDENS ENESTE OG EKSKLUSIVE OPPREISNING, OG HAR FORTRINN FOR ALLE ANDRE GARANTIER, UTTRYKK ELLER UNDERFORSTÅTT, INKLUDERT, MEN IKKE BEGRENSET TIL EVENTUELLE UNDERFORSTÅTTE GARANTIER FOR SALGBARHET ELLER ANVENDELIGHET TIL ET BESTEMT FORMÅL. FLUKE ER IKKE ANSVARLIG FOR EVENTUELLE SPESEILLE, INDIREKTE, TILFELDIGE ELLER KONSEKVENSSKADER ELLER TAP, INKLUDERT TAP AV DATA, SOM FØLGE AV EVENTUELL ÅRSAK ELLER TEORI.

Siden noen land eller stater ikke tillater begrensninger i begrepet underforstått garanti, eller utelatelse eller begrensning av tilfældige skader eller følgeskader, er det mulig at begrensningene og utelatelsene i denne garantien ikke gjelder for alle kjøpere. Hvis noen av forutsetningene i denne garantien anses å være ugyldig eller umulig å håndheve av en rett eller annen myndighet i rettmessig rettskrets, vil slik holding ikke ha innvirkning på gyldigheten eller håndhevelsen av noen andre forutsetninger.

BEGRÄNSAD GARANTI OCH ANSVARSBEGRÄNSNING (Swedish)

Varje Flukeprodukt garanteras vara fri från felaktigheter i material och utförande vid normal användning och service. Garantiperioden är 2 år och räknas från leveransdagen. För delar, produktreparationer och service gäller 90 dagars garanti. Denna garanti gäller endast för den ursprungliga köparen eller slutkunden, som handlat hos en auktoriserad Flukeåterförsäljare, och omfattar inte säkringar, engångsbatterier eller produkter, som enligt Flukes förmenande har använts på felaktigt sätt, ändrats, smutsats ner eller skadats till följd av olyckshändelse eller onormala användningsförhållanden eller onormal hantering. Fluke garanterar att programvaran fungerar i allt väsentligt i enlighet med dess funktionella specifikationer i 90 dagars tid, och att den lagrats på korrekt sätt på icke-defekta datamedia. Fluke garanterar inte att programvaran är feilfri och heller inte att den fungerar utan avbrott.

Flukes auktoriserade återförsäljare förmedlar denna garanti endast till slutanvändarkunder för nya och obegagnade produkter, men har ingen behörighet att erbjuda en mer omfattande eller annorlunda garanti i Flukes namn. Garantisupport finns endast tillgänglig om produkten köpts i av Fluke auktoriserad butik, eller om köparen erlagt det tillämpliga internationella priset. Fluke förbehåller sig rätten att debitera köparen för importkostnaden för reparations/ersättningsdelar, om en produkt som inköpts i ett land lämnas in för reparation i ett annat land.

Flukes garantitägande begränsar sig till, efter Flukes bedömning, antingen återbetalning av inköpspriset, kostnadsfri reparation eller utbyte av en felaktig produkt, som lämnas in/återsänds till av Fluke auktoriserad serviceverkstad under garantitiden.

För att få garantiservice kontaktar du närmaste av Fluke auktoriserade serviceverkstad för returtillstånd, och skickar sedan produkten till serviceverkstaden ifråga med en beskrivning av de problem som föreligger, med sändnings- och servicekostnaderna förbetalda (FOB destinationen). Fluke tar inte på sig något ansvar för skador som kan uppkomma vid försändningen. Efter garantireparationen återsänds produkten till köparen, med sändningskostnaderna förbetalda (FOB destinationen). Om Fluke bedömer att felet har förorsakats av forsumelse, felaktig användning, nedsmutsning, ändring, olyckshändelse eller onormala förhållanden eller onormal hantering, inberäknat överspanningsfel till följd av användning utanför de värden som specificerats för produkten, eller normal försilting av mekaniska komponenter, kommer Fluke and lämna besked om de uppskattade reparationskostnaderna och invänta godkännande av dessa innan arbetet påbörjas. Efter reparationen återsänds produkten till köparen med sändningskostnaden förbetald varefter köparen faktureras för reparationskostnaden och återsändningskostnaden (FOB leveransstället).

DENNA GARANTI ÄR KÖPARENS ENDA GOTTGÖRELSE OCH ERSÄTTER ALLA ANDRA GARANTIER, UTTRYCKLIGA ELLER UNDERFÖRSTÅDDA, INKLUSIVE MEN INTE BEGRÄNSAT TILL GARANTIER AVSEENDE SÄLJBARHET ELLER LÄMPLIGHET FÖR EN VISS ANVÄNDNING. FLUKE KAN INTE GÖRAS ANSVARIG FÖR NÅGRA SPECIELLA SKADOR, INDIREKTA SKADOR, OFÖRUTSEDDA SKADOR ELLER FÖLJDSKADOR, INKLUSIVE FÖRLORADE DATA, OAVSETT ANLEDNING ELLER TEORETISK ORSAK.

Vissa stater eller länder tillåter inte begrensningar av en underförstådd garantis löptid, eller undantag eller begränsning av tillfälliga skador eller följskador, varför begränsningarna och undantagen i denna garanti kanske inte gäller för varje köpare. Om något villkor i denna garanti skulle konstateras vara ogiltigt eller otillämpbart av en behörig domstol eller motsvarande, skall ett sådant utslag inte inverka på giltigheten eller tillämpbarheten hos något annat villkor.

有限的保修及责任范围

每一 Fluke 产品都担保在正常使用和保养的情况下，不会发生材料和工艺上的瑕疵。两年的担保期间由产品发货之日算起。零件、产品修理和服务有 90 日担保期限。本担保仅限于 Fluke 授权零售商的原购买人或最终用户，并不适用于保险丝、一次性电池、或 Fluke 认为由于意外或异常操作或处理状况而被滥用、改装、疏忽、污染或损坏的任何产品。Fluke 担保软件在 90 日内依据正常规格持续运作，并存储在无瑕疵的媒介上。Fluke 并不担保软件毫无错误或可中断运作。

Fluke 授权的零售商应仅对最终用户就新的和未用的产品提供本担保，但无权代表 Fluke 公司提供额外或不同的担保。仅对在 Fluke 授权的出销点的或那些已支付适当的国际价购买产品的购买者提供担保支持。在一国购买的产品需在他国修理时，Fluke 有权向买方要求负担重大修理/零件更换费用。

Fluke 的担保为有限责任，由 Fluke 决定是否退还购买金额、免费修理或更换在担保期间退还 Fluke 授权的维修中心的瑕疵产品。

要求担保维修服务，请与您就近的 Fluke 授权维修中心联系，获得退还授权信息；然后将产品寄至维修中心，并说明产品使用上的问题、并负担邮资和保险费用（目的地离岸价格）。Fluke 不承担运途中产生的损坏。在担保修理之后，产品将预付运费送还买方（目的地离岸价格）。如果 Fluke 认定产品故障是由于疏忽、滥用、污染、修改、意外或不当操作或处理状况而产生，包含使用超出产品特定的特定额定值而导致过电压故障，或是由于机件日常使用损耗，则 Fluke 会估计修理费用，在实际修理之前先获得买方同意。修理之后，产品将预付运费送还买方，而买方将负担修理费用和运费（运送点离岸价格）。

本担保为购买者唯一且专有的补偿办法，代替任何其他明示或暗示的担保，包括但不限于任何适售性或符合特殊目的的担保。Fluke 不应对任何特殊、间接、偶发或后续的损坏或损失负责，包括由于任何原因或理论的数据丢失在内。

由于某些国家或地区不允许限制上述担保的限制条件；或排除或限制偶发或后续的损坏担保，因此本担保的限制和排除可能并不适用于买方。如果本担保有任何条款被法院或其他拥有适当管辖权的决策者判定为无效或不得生效，则此类判决将不会影响其他任何条款的有效性或可生效性。

Fluke Corporation
P.O. Box 9090
Everett, WA 98206-9090
USA

Fluke Europe B.V.
P.O. Box 1186
NL-5602 BD Eindhoven
Holland

11/99

